

Article number: 0101053
 Description: Retaining ring A 36 DIN 471
 Spring steel
 Note: Fitted with ZGA pilers

Measures

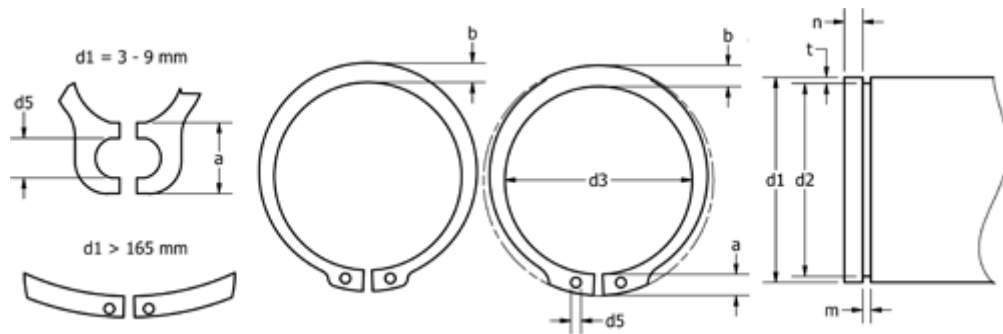

a max	= 5.6	FN kN	= 18.3	s	= 1.75
AN mm ²	= 110.0	FRg kN	= 9.00	t	= 1.00
b	= 4.0	FR kN	= 49.40	tol	= -0.25
d1	= 36	g	= 2.0	tol	= -0.06
d2	= 34.0	K kN-mm	= 95.80	tol	= +0,25-0,50
d3	= 33.2	m min	= 1.85	Tong	= ZGA-2
d5 min	= 2.5	n abl x 1000	= 15.0	Weight kg/1000	= 5.000
Description	= A36	Nominal drive	= 3.0		